

SLK205-W/L/SIL

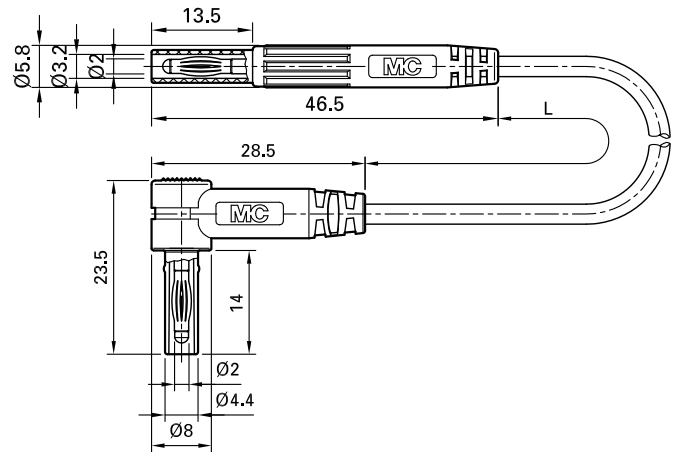

Data sheet SLK205-W/L/SIL 08.2022

Item number 65.9578-*

Highly flexible, one end with molded in-line Ø 2 mm MULTILAM plug with rigid insulating sleeve. The other end with molded right-angled Ø 2 mm MULTILAM plug with rigid insulating sleeve.

Technical data	
Diameter of plug system	2 mm
Rated Values	600 V, CAT III, 10 A
Surface treatment electrical contact	Au
Base material electrical contact	CuZn
Standard color(s) *	21 22
Optional color(s)	23 24 25 29
Lead lengths <input type="text"/>	100 cm
Lead insulation	SIL
Lead cross section	0,5 mm ²
Test accessory acc. to	IEC EN 61010-031

Technical data

Approvals

CE